

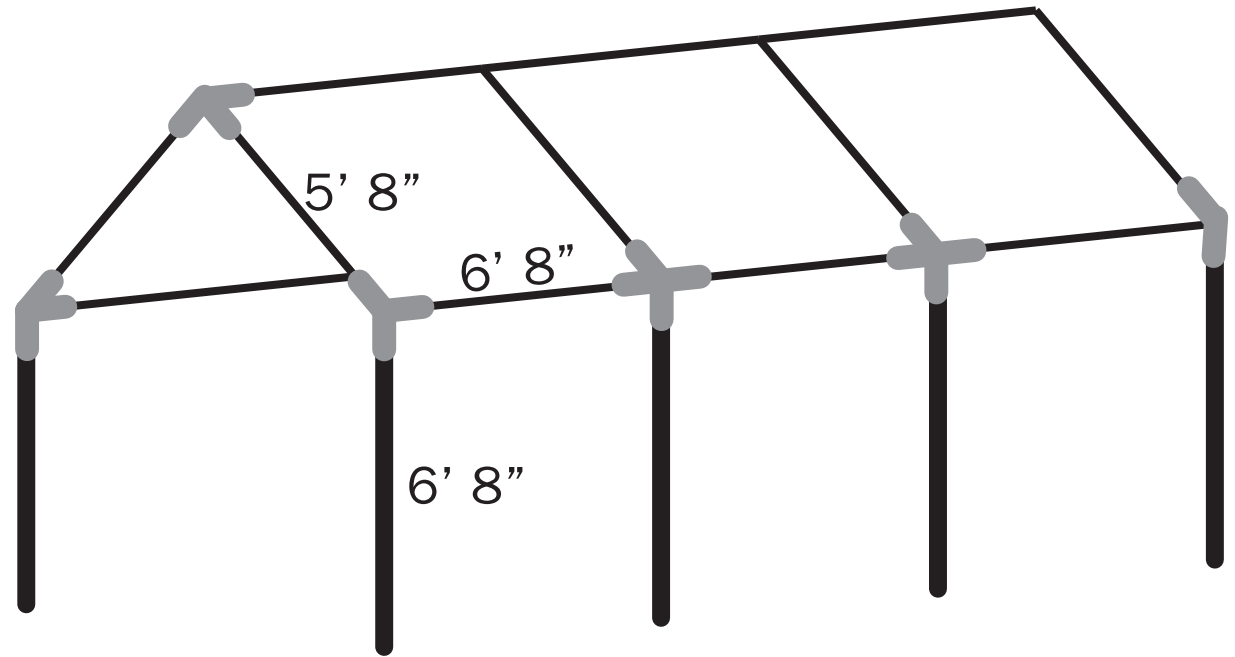

MIDLAND LIQUIDATORS
1234 KINGSWAY, VANCOUVER BC
tel 604 875 9722

10 x 20 BASIC CANOPY

- 8 – Peak Poles 5' 8"
- 9 – Cross Brace Poles 6' 8"
- 8 – Leg Poles 6' 8"
- 6 – 3-way Brackets
- 6 – 4-way Brackets
- 50 – Ball bungees
- 1 – Canopy Tarp 10 x 20



Instructions

1. Assemble roof structure first.
2. Put tarp on structure attaching the corner tie first then place all ball bungees alternating one side and then the other.
3. Insert legs one side at a time.
4. We **STRONGLY RECOMMEND** that you anchor your canopy to the ground.

We do not guarantee our canopy against snow and wind